

Magnetic cylinder sensors

MZTK 06P1013/KS35D

dimension drawing

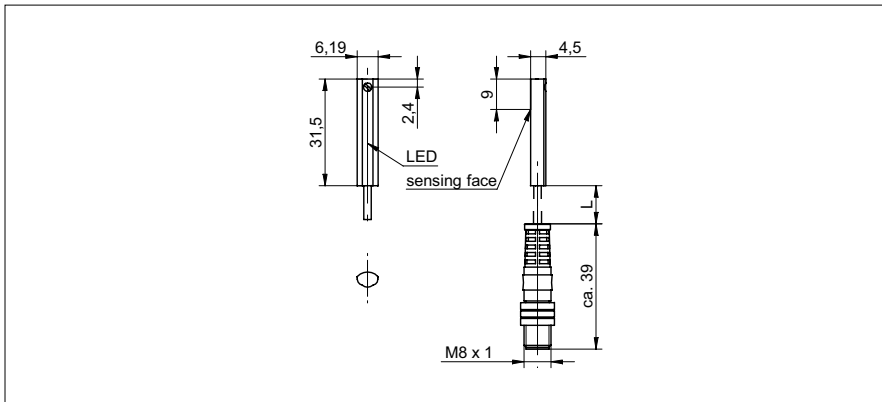

general data

type	magneto-resistive
version	T-slots
nominal operation point	4 mT
difference ON-OFF	0,5 ... 1,5 mT
output indicator	LED yellow

electrical data

switching frequency	< 200 kHz
response time / release time	< 0,0025 ms
output circuit	PNP
current consumption max. (no load)	12 mA
output current	< 200 mA
voltage supply range +Vs	6 ... 30 VDC
output function	normally open (NO)
voltage drop Vd	< 1 VDC
reverse polarity protection	yes
short circuit protection	yes

mechanical data

cable output	axial
connection types	flylead connector PUR M8, L=300 mm
type	rectangular
depth	31,5 mm
width / diameter	6,2 mm
height / length	4,5 mm
housing material	PA66

ambient conditions

operating temperature	-40 ... +70 °C
protection class	IP 67

photo



connection diagram



installation drawing

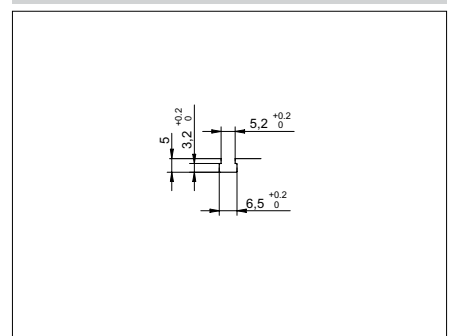

• Oil- and salt water climate resistant